

SERIES TUF | DWYER ULTRASONIC ENERGY METER

FEATURES/BENEFITS

- Lower maintenance costs with local parameter display and no moving parts
- BACnet MS/TP or Modbus RTU data communication protocol output allows for easy transfer of data
- Flow and temperature monitor in one unit eliminates the need for multiple units
- Produced to meet EN1434 MID approval for accuracy and quality

APPLICATIONS

- Heat metering
- Utilities billing
- Tenant billing
- Monitoring of water heating or cooling: radiators, fan coils

DESCRIPTION

The **SERIES TUF** Tennant Ultrasonic BTU Flowmeter is a highly accurate and stable energy meter. It utilizes ultrasonic technology to measure heating and cooling energy consumption. The Series TUF incorporates a flowmeter, temperature meter, and a calculator into a single, compact unit. The size and lack of moving parts means the Series TUF requires minimal maintenance. The 8-digit LED display enables easy reading of the meter's recorded values; including temperature, flow-rate, energy consumption, etc. These features make it ideal for installation on chillers, boilers, and individual apartment piping. With the optional couplings it is capable of being used with either NPT or BSPT pipe sizes. It is the perfect meter for tenant billing applications.



SPECIFICATIONS

Service	Clean, compatible liquids.
Wetted Materials	Brass and 316L SS.
Range	See chart.
Display	8-digit LED.
Accuracy	BTU: EN1434/CJ128 Class 2; Flow: $\pm(2+(0.02 Qp/Q))\%$; Temperature: $\pm 0.1^\circ\text{C}$.
Power Requirements	24 VAC/VDC or 3.6 V ER26500 lithium metal battery, user supplied and installed, battery acts as back-up if power is lost.
Power Consumption	1 W.
Temperature Limits	Ambient: 41 to 131 °F (5 to 55 °C); Process: 36 to 203 °F (2 to 95 °C).
Humidity Limit	<93%.
Pressure Limits	232 psi (16 bar) for DN15 to DN40; 362 psi (25 bar) for >DN50.
Pressure Drop	<1.5 psi (10 kPa).
Process Connection	See chart.
Serial Communications	Modbus® RTU or BACnet® MSTP (selectable)**.
Enclosure Rating	IP65.
Enclosure Material	Plastic.
Repeatability	Flowmeter: 1%.
Electric Connections	3 ft (0.91 m) 4x0.2 mm ² cable with terminal block.
Flow Direction	Unidirectional.
Mounting Orientation	Horizontal or vertical.
Weight	See chart
Agency Approvals	CE.



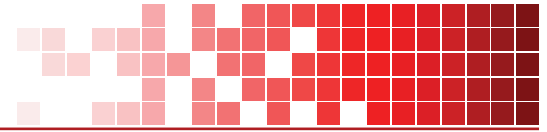

DIMENSIONS & WIRING DIAGRAM

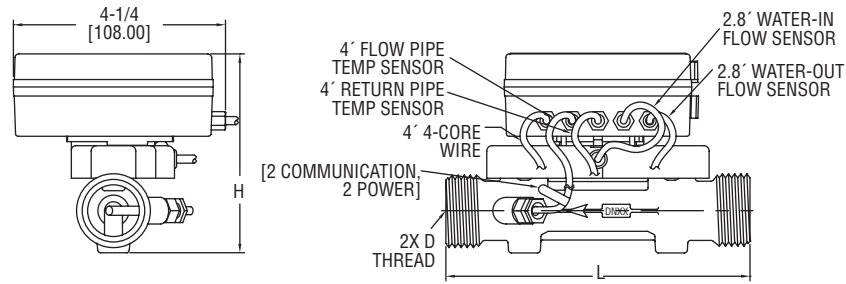

Model	Dimensions in [mm]			Flow Rate GPM [LPM]			Weight lb [kg]
	L	D	H	Max Flow (Qs)	Nominal Flow Range (Qp)	Min Flow (Qi)	
TUF-150-XX	4-21/64 [110.00]	G3/4B	3-31/32 [101.00]	13 [50]	6.6 [25]	0.1 [0.5]	3.1 [1.4]
TUF-200-XX	5-1/8 [130.00]	G1B	3-31/32 [101.00]	22 [83]	11 [42]	0.2 [0.8]	3.1 [1.4]
TUF-250-XX	6-19/64 [160.00]	G11/4B	4-11/64 [106.00]	31 [117]	15 [58]	0.3 [1.2]	4.1 [1.8]
TUF-320-XX	7-3/32 [180.00]	G11/2B	4-29/64 [113.00]	53 [200]	26 [100]	0.5 [2]	5.2 [2.3]
TUF-400-XX	7-7/8 [200.00]	G2B	4-49/64 [121.00]	88 [333]	44 [167]	0.9 [3.3]	6.6 [3.0]

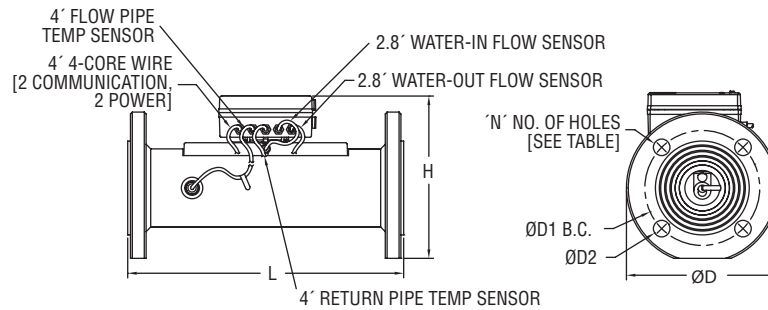

Model	Dimensions in [mm]					N	Flow Rate GPM [LPM]			Weight lb [kg]
	L	ØD	H	ØD1	ØD2		Max Flow (Qs)	Nominal Flow Range (Qp)	Min Flow (Qi)	
DN50 TUF-500-XX	11-13/16 [300.00]	6-1/2 [165.00]	6-57/64 [175.00]	4-59/64 [125.00]	45/64 [18.00]	4	132 [500]	66 [250]	0.7 [2.5]	30.8 [14]
DN65 TUF-650-XX	11-13/16 [300.00]	7-9/32 [185.00]	7-23/32 [196.00]	5-45/64 [145.00]	45/64 [18.00]	4	220 [833]	110 [417]	1.1 [4.2]	30.2 [13.7]
DN80 TUF-800-XX	13-25/32 [350.00]	7-7/8 [200.00]	8-1/2 [216.00]	6-19/64 [160.00]	45/64 [18.00]	8	352 [1333]	176 [667]	1.8 [6.7]	37.5 [17]
DN100 TUF-1000-XX	13-25/32 [350.00]	8-21/32 [220.00]	9-11/64 [233.00]	7-3/32 [180.00]	45/64 [18.00]	8	528 [2000]	264 [1000]	2.6 [10]	41.8 [19]
DN125 TUF-1250-XX	13-25/32 [350.00]	9-27/32 [250.00]	10-25/64 [264.00]	8-17/64 [210.00]	45/64 [18.00]	8	881 [3333]	440 [1667]	4.4 [17]	57.3 [26]
DN150 TUF-1500-XX	11-13/16 [300.00]	11-7/32 [285.00]	11-29/64 [291.00]	9-29/64 [240.00]	55/64 [22.00]	8	1321 [5000]	660 [2500]	6.6 [25]	70.5 [32]
DN200 TUF-2000-XX	11-13/16 [350.00]	13-25/64 [340.00]	13-21/32 [347.00]	11-39/64 [295.00]	55/64 [22.00]	12	2202 [8333]	1101 [4167]	11 [42]	141 [64]

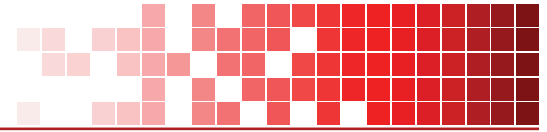

INSTALLATION

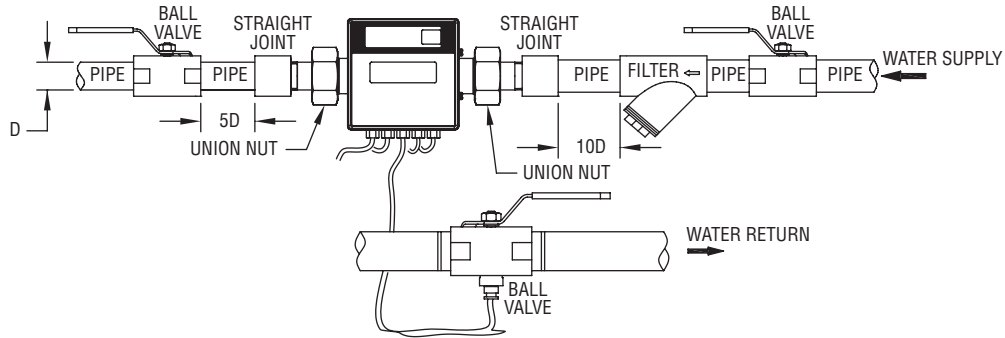

Installation Diagram for TUF-150/400

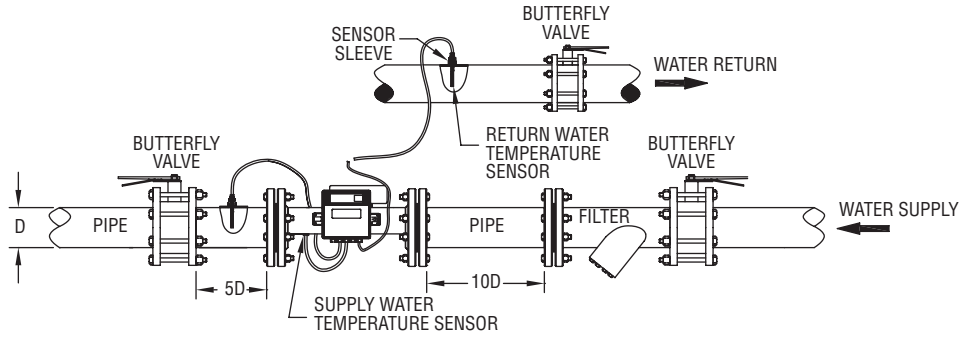

Installation Diagram for TUF-500/2000

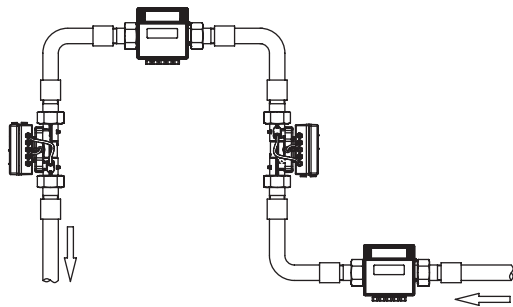

Installation Positions

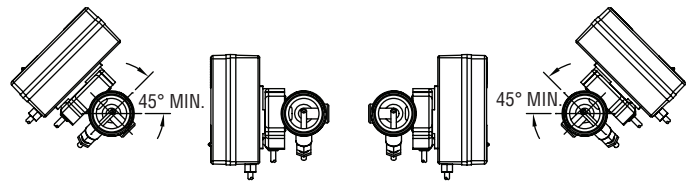

Mounting Rotation

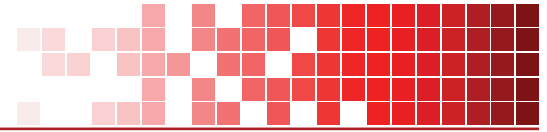

HOW TO ORDER

- Choose 1 ultrasonic energy meter model
 - Choose pipe fitting model given the appropriate fitting size (for DN15 to DN40 only)*
- Example:** TUF-150-MD, Fitting Size: A, select pipe fitting Model WM-ACC-C01 or WM-ACC-C11.

Ultrasonic Energy Meter Model	Body Size†	Pipe Size		Fitting Size	Communication	Meter Connection	GPM (LPM)			Weight lb (kg)
		in	mm				Min Flow (Qi)	Nominal Flow Range (Qp)	Max Flow (Qs)	
TUF-150-MD	DN15	1/2	15	A	Modbus®	G-3/4	0.1 (0.5)	6.6 (25)	13 (50)	3.1 (1.4)
TUF-200-MD	DN20	3/4	20	B	Modbus®	G1	0.2 (0.8)	11 (42)	22 (83)	3.1 (1.4)
TUF-250-MD	DN25	1	25	C	Modbus®	G1-1/4	0.3 (1.2)	15 (58)	31 (117)	4.1 (1.8)
TUF-320-MD	DN32	1-1/4	32	D	Modbus®	G1-1/2	0.5 (2)	26 (100)	53 (200)	5.2 (2.3)
TUF-400-MD	DN40	1-1/2	40	E	Modbus®	G2	0.9 (3)	44 (167)	88 (333)	6.6 (3)
TUF-500-MD*	DN50	2	50	-	Modbus®	Flange	1.3 (5)	66 (250)	132 (500)	33 (15)
TUF-150-BN	DN15	1/2	15	A	BACnet	G-3/4	0.1 (0.5)	6.6 (25)	13 (50)	3.1 (1.4)
TUF-200-BN	DN20	3/4	20	B	BACnet	G2	0.2 (0.8)	11 (42)	22 (83)	3.1 (1.4)
TUF-250-BN	DN25	1	25	C	BACnet	G1-1/4	0.3 (1.2)	15 (58)	31 (117)	4.1 (1.8)
TUF-320-BN	DN32	1-1/4	32	D	BACnet	G1-1/2	0.5 (2)	26 (100)	53 (200)	5.2 (2.3)
TUF-400-BN	DN40	1-1/2	40	E	BACnet	G2	0.9 (3)	44 (167)	88 (333)	6.6 (3)
TUF-500-BN*	DN50	2	50	-	BACnet	Flange	1.3 (5)	66 (250)	132 (500)	33 (15)

*A pipe fitting is required to use the DN15 to DN40 energy meters. The DN50 has a flange connection and does not require a pipe fitting.
 †For additional sizes up to 8" (203.2 mm) contact factory.

ACCESSORIES

Fitting Size	Pipe Fitting Model*	Process Connection Size	Weight lb (kg)
A	WM-ACC-C01	1/2" NPT	0.6 (0.3)
A	WM-ACC-C11	1/2" BSPT	0.6 (0.3)
B	WM-ACC-C02	3/4" NPT	1.2 (0.5)
B	WM-ACC-C12	3/4" BSPT	1.2 (0.5)
C	WM-ACC-C03	1" NPT	1.8 (0.8)
C	WM-ACC-C13	1" BSPT	1.8 (0.8)
D	WM-ACC-C04	1-1/4" NPT	2.3 (1.1)
D	WM-ACC-C14	1-1/4" BSPT	2.3 (1.1)
E	WM-ACC-C05	1-1/2" NPT	4.4 (2)
E	WM-ACC-C15	1-1/2" BSPT	4.4 (2)

*Each model includes 1 fitting.

Modbus® is a registered trademark of Schneider Automation, Inc.

Important Notice: Dwyer Instruments, Inc. reserves the right to make changes to or discontinue any product or service identified in this publication without notice. Dwyer advises its customers to obtain the latest version of the relevant information to verify, before placing any orders, that the information being relied upon is current.

